

Hamburg

User Manual

VRH-HAMBURG-30SS/36SS



Vesta

Simple Kitchen Solutions

Table of Contents

Important Safety Notice	4
Height & Clearance Requirement	9
Venting Requirement	10
Venting Methods	12
Electrical Requirement	13
Tools Needed	14
Parts Supplied	15
Product Dimensions	16
Installation	17
Operations	22
Specification	24
Trouble Shooting	25
Replacing the Light Bulb	27
Use & Care	28
Maintenance	29
Warranty	31
Disclaimer	34
Contact Us	35

Important Safety Notice

READ ALL INSTRUCTIONS BEFORE INSTALLING AND OPERATING THIS APPLIANCE

- The installation in this manual is intended for qualified installers, service technicians or persons with similar qualified background. Installation and electrical wiring must be done by qualified professionals and in accordance with all applicable codes and standards, including fire-rated construction.
- **DO NOT** attempt to install this appliance yourself. Injury could result from installing the unit due to lack of appropriate electrical and technical background.
- Range hood may have very sharp edges; please wear protective gloves if it is necessary to remove any parts for installing, cleaning or servicing.
- Activating any switch **ON** before completing installation may cause ignition or an explosion.
- Due to the size and weight of this range hood, two people installation is recommended.

TO REDUCE THE RISK OF FIRE, ELECTRIC SHOCK, OR INJURY TO PERSONS:

- For general ventilating use only. **DO NOT** use to exhaust hazardous or explosive materials and vapors.
- The combustion air flow needed for safe operation of fuel-burning equipment may be affected by this unit's operation. Follow the heating equipment manufacturer's guideline and safety standards such as those published by the National

Fire Protection Association (NFPA), and the American Society of Heating, Refrigeration and Air Conditioning Engineers (ASHRAE), and the local code authorities.

- Before servicing or cleaning unit, switch power OFF at service panel and lock service panel to prevent power from being switched ON accidentally.
- Clean grease laden surfaces frequently. To reduce the risk of fire and to disperse air properly, make sure to vent air outside. DO NOT vent exhaust into spaces between walls, crawl spaces, ceiling, attics or garages.
- Ducted fans MUST always be vented to the outdoors.
- Use only metal ductwork and this unit MUST be grounded.
- Sufficient air is needed for proper combustion and exhausting of gases through the duct to prevent back drafting.
- When cutting or drilling into wall or ceiling, be careful not to damage electrical wiring or other hidden utilities.
- All electrical wiring must be properly installed, insulated and grounded.
- Old duct work should be cleaned or replaced if necessary to avoid the possibility of a grease fire.
- Check all joints on duct work to insure proper connection and all joints should be properly taped.
- Use this unit only in the manner intended by the manufacturer. If you have questions, contact the vendor.

TO REDUCE THE RISK OF A STOVE TOP GREASE FIRE:

- Keep all fan, baffle, spaces, filter, grease tunnel, oil container and grease-laden surfaces clean. Grease should not be allowed to accumulate on fan, baffle, spaces, filter, grease tunnel and oil container.
- Always turn range hood ON when cooking at high heat or when cooking flaming foods.
- Use high settings on cooking range only when necessary.
- Never leave surface units unattended at high settings. Boil overs cause smoking and greasy spillovers that may ignite. Heat oils slowly on low or medium settings.
- Clean ventilating fan frequently.
- Always use appropriate cookware and utensils size.
- Always use cookware appropriate for the size of the surface element.

TO REDUCE THE RISK OF INJURY TO PERSONS IN THE EVENT OF A STOVE TOP GREASE FIRE:

- **SMOTHER FLAMES** with a close-fitting lid, cookie sheet, or metal tray, then turn OFF the burner. **BE CAREFUL TO PREVENT BURNS. NEVER PICK UP A FLAMING PAN**—you may be burned. **KEEP FLAMMABLE OR COMBUSTIBLE MATERIAL AWAY FROM FLAMES.** If the flames **DO NOT** go out immediately, **EVACUATE AND CALL THE FIRE DEPARTMENT** or dial your local emergency service immediately.
- **DO NOT USE WATER**, including wet dishcloths or towels — a violent steam explosion will result.

- Use an extinguisher **ONLY** if:
- You know you have a Class A, B, C extinguisher, and you already know how to operate it.
- The fire is small and contained in the area where it is started.
- The fire department is being called.
- You can fight the fire with your back to an exit.

TO REDUCE THE RISK OF INJURY TO PERSONS IN THE EVENT OF A GAS LEAKS:

- Extinguish any open flame.
- **DO NOT** turn on the range hood fan or any type of ventilator.
- **DO NOT** turn on the lights or any type of appliance.
- Open all doors and windows to disperse the gas. If you still smell gas, call the gas company and fire department, or dial your local emergency service immediately.
- Your safety and the safety of others is very important. We have provided many important safety messages in this manual and on your appliance. Always read and obey all safety messages. All safety messages will tell you what the potential hazard is, tell you how to reduce the chance of injury, and tell you what can happen if the instructions are not followed.



This is the safety alert symbol. This symbol alerts you to potential hazards that can hurt you and others. All safety messages will follow the safety alert symbol and the word “WARNING”.

The manufacturer and/or distributor/reseller declines all responsibility in the event of failure to observe the instructions given here for installation, maintenance and suitable use of the product.

The manufacturer and/or distributor/reseller further declines all responsibility for injury due to negligence and the warranty of the unit automatically expires due to improper maintenance.

The manufacturer and/or distributor/reseller will not be held responsible for any damages to personal property or real estate or any bodily injuries whether caused directly or indirectly by the range hood.

Height & Clearance

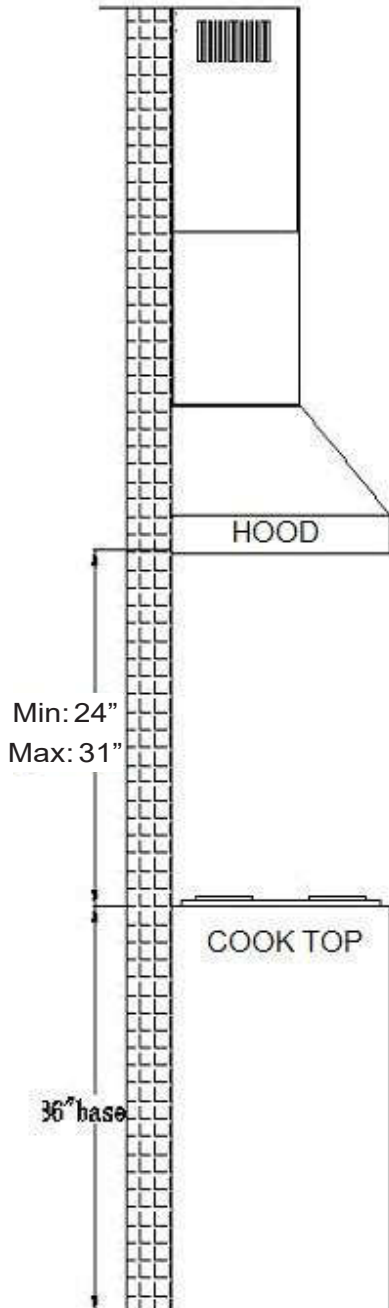

Venting Requirements

Hood mounted too low could result in heat damage and fire hazard; while hoods mounted too high will be hard to reach and will lose its performance and efficiency.

Use metal duct work only. Rigid metal vent is recommended. A minimum of 6" round (standard for this range hood, purchased separately must be used to maintain maximum airflow efficiency

DO NOT use plastic vent.

DO NOT use 4" (10.2 cm) laundry-type wall caps

Fasten all connections with sheet metal screws and tape all joints with aluminum tape.

For the most efficient & quiet operation:

A distance of 24" to 31" is recommended* between stove top and the bottom of range hood.

It is recommended that the range hood be vented vertically through the roof through 6" or bigger round metal/aluminum vent work.

ALWAYS, when possible, reduce the number of transitions and turns. If long duct run is required, increase duct size from 6" to 7" or 8". If a reducer is used, install a long reducer instead of a pancake reducer. Reducing duct size will restrict airflow and decrease airflow, thus reduce duct size as far away from opening as possible.

If turns or transitions are required: Install as far away from

opening and as far apart, between 2, as possible.

The size of the vent should be uniform.

Use no more than three 90° elbows.

Make sure there is a minimum of 24" of straight vent between the elbows if more than one elbow is used.

DO NOT install two elbows together.

Venting Methods

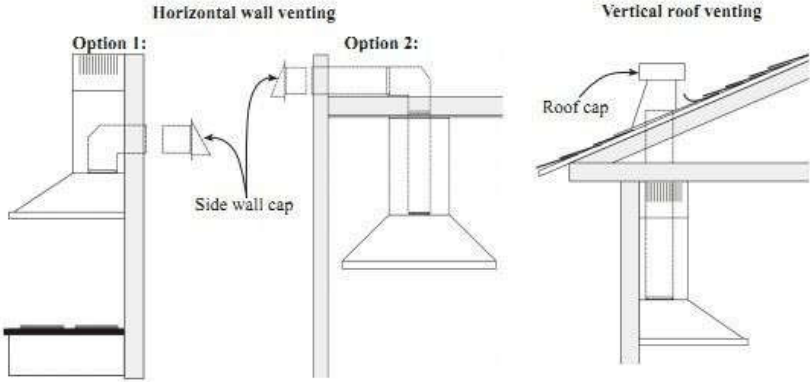

Electrical Requirements

IMPORTANT: Observe all governing building codes and city ordinances. A 120 volt, 60 Hz., AC only, 15-amp, fused electrical circuit is required.

It is the customer's responsibility:

- To contact a qualified electrical installer.
- To assure that the electrical installation is adequate and in conformance with National Electrical Code, ANSI/ NFPA 70 — latest edition*, or CSA Standards C22. 1-94, Canadian Electrical Code, Part 1 and C22. 2 No. 0-M91 - latest edition** and all local codes and ordinances.

Tools Needed

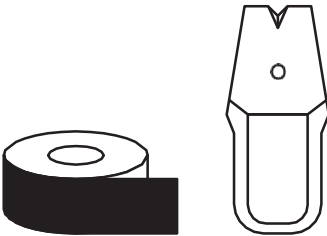
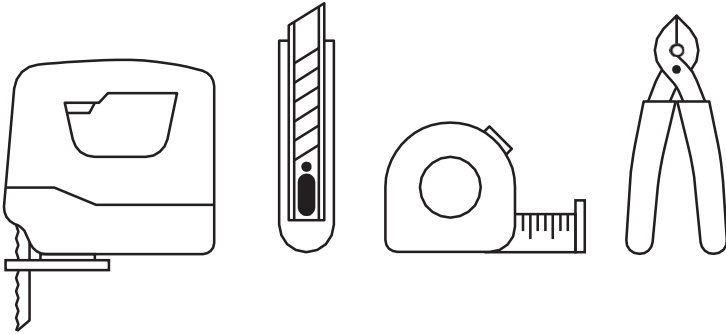
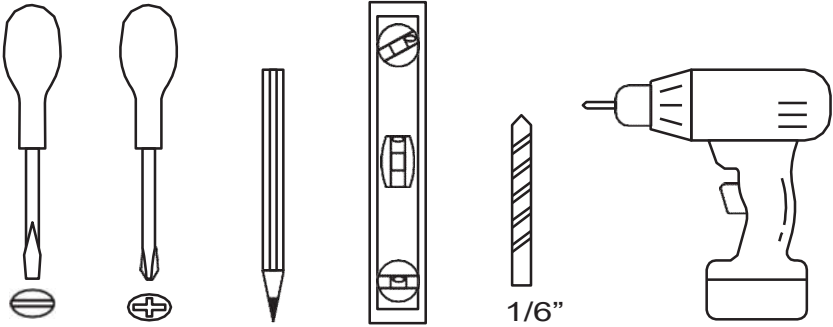

Parts Supplied



Range Hood
x1



Baffle Filters



Ceiling Bracket



Grease Tunnel

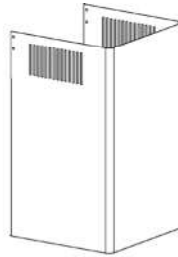

Inside Chimney

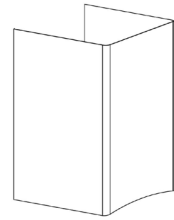

Outside Chimney



Chimney Screws
x4



Mounting Screws
x4



Anchors
x4



Aluminum Vent

Product Dimensions

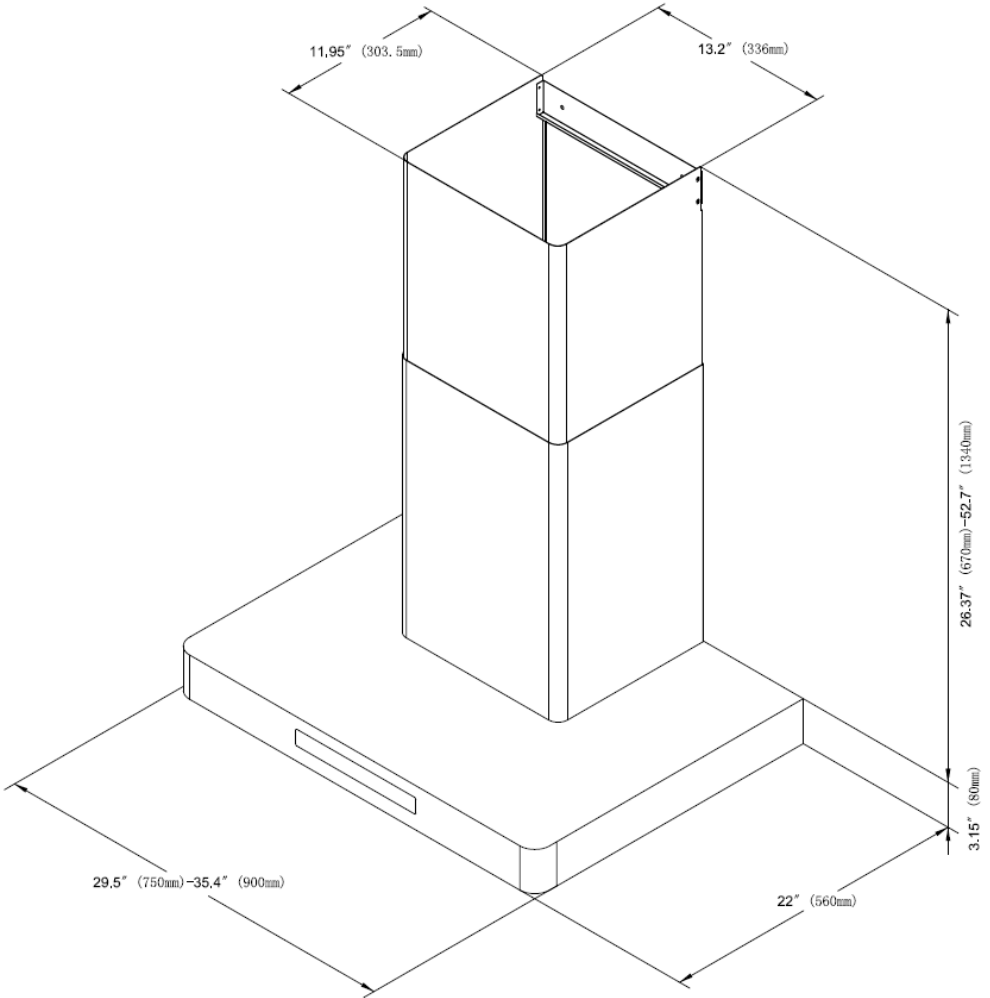

Installation

STEP 1: (OPTIONAL ONLY) Protect the cook top & create work station

Have 2 piece of wood stub about 2" x 4" x 20" on both sides of stove and a plywood on top of them to protect cook top or stove from damage or dirt. This plywood will also create a comfortable work station for easy to install.



STEP 2: Marking on the wall

- Center: is center of cook top or stove
- Chimney width: is the width of the chimney (Vary in each model)
- Mounting screws: Is where the hood body will be hanging from.

Please assemble mounting bracket to hood body first so you can find exact dimension.

****MOUNT SCREW HOLE DIMENSIONS:**

WIDTH: is dimension from center to center of mounting bracket

hole

HEIGHT: is dimension from cook top to bottom of range hood (vary from 24" to 31") plus from bottom of range hood to mounting bracket hole.

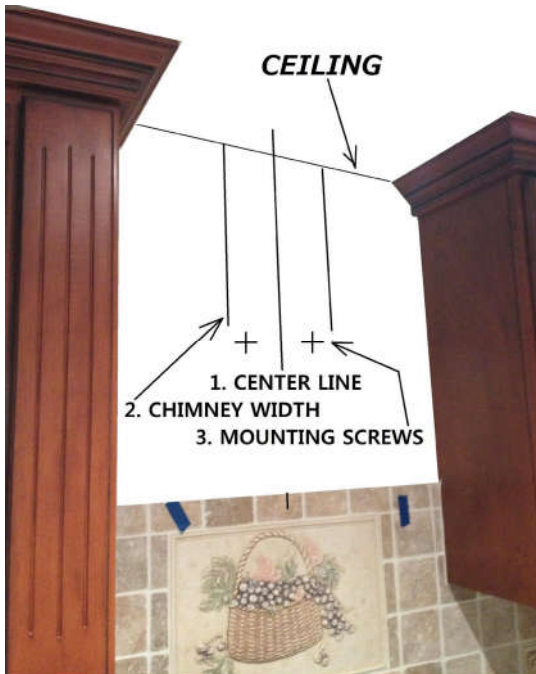

STEP 3: prepare ductwork & single outlet (skip this step if you already have it)

Have 15amp, 120V, 60Hz, single outlet anywhere inside the chimney width lines (make sure at least 2 inches below ceiling line for ceiling bracket mount)

Have 6 inches diameter ductwork hanging down from ceiling to the mark of mounting screws. (2 inches away from wall is recommended since you need room for plug in and out)



STEP 4: install ceiling bracket, mounting anchors and screws

Place center of upper chimney bracket inline with centerline and all the way up to ceiling then screw it to the wall.

Pre-drill holes where your mounting marks are, then insert wall anchors and mounting screws, make sure leaving 1/6" space away from the wall.

STEP 5: Hang the hood and connect

Carefully hang the hood body on the wall, attaching it to the 2 screws already in place.

Level the hood body by using horizontal level

Use hand screw driver to tight those 2 mounting screws

Connect the exhaust on the hood to the ductwork above.

Use aluminum tape to make all joints secure and all tight

Find the three pronged plug and connect to an electrical outlet

CAUTION: Do not release the hood yet until you finish Step 6 below.



STEP 6: Install chimney

Take off outsider chimney protective laminate coating (not the inner chimney)

Place both the chimney on top of range hood base

Make sure the chimney is facing the correct direction

Attach the inside chimney to the ceiling mounting bracket

Screw the chimney into place on both sides

STEP 7: Install oil tunnel

Drop oil tunnel into recess support near rear of hood.

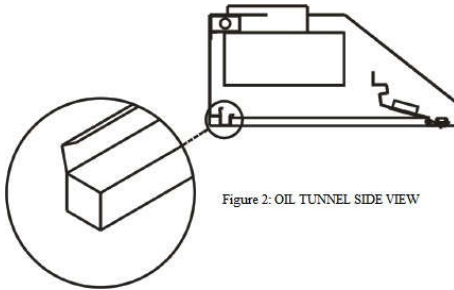

Figure 2: OIL TUNNEL SIDE VIEW

STEP 9: Install baffle filters

Angle baffle filter toward back of hood.



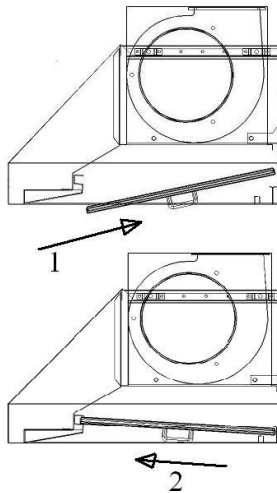

Lift a baffle filter up above horizontal level then slide forward into slot behind the front of hood.

To remove the baffle, please reverse the process.



Operations







1.  Power: tap to turn on the range hood. (Hold for 3 seconds will turn on/off the gesture sensor.)
2.  Light: tap to turn on the light. (Hold the light button to change the brightness level.)
3.  Fan button: first touch will run the speed F1 (Hold for 3 seconds will turn on/off the voice control sensor.)
4.  Fan button: first touch will run the 1st speed F1, and then increase the settings until speed F16. Then touch again, return back speed F1.
5.  Timer: only works when the range hood fan is running, touch once, the timer has a default decrease or increase the time duration optionally.

Gesture sensing control:

1. Wave hand from left to right once, the hood starts working at Speed 2 (F2).
2. Wave hand from left to right twice, the hood starts working at Speed 4 (F4).
3. Wave hand from left to right third, the hood starts working at Speed 6 (F6).
4. Wave hand from left to right, speed will increase until to Speed 16 (F16).
5. When wave your hand from right to left, speed starts to decrease.

Set the clock:

1. Hold the clock button  for 5 seconds, the hours will blink  plus button to set the hour.
2. Tap the clock button  again to switch to the minutes  setting plus button to set the minutes.
3. Tap the power button  to finish setting the clock.

(Note: You will need to reset the clock if the power supply was cut off.)

Memory function:

The smart control technology provides a memory function for speed and light level, the range hood will automatically operate at the same speed and light level the next time you turn it on, eliminating the need to adjust it manually.

Finger swipe operation:

There are 16 speeds in total, which means it is divided into 5 sections. Each slide will advance into two gears, 3-6-9-12-16.



The starry sky background flashes dynamically according to the wind speed. The faster the windspeed, the higher the frequency.



Voice-activated control:(Hi Vesta)

Talking to Vesta is a quick way to get things done, when you activate Vesta with your voice, Vesta respond out loud:



- | | |
|----------------------|------------------------------|
| • Hi Vesta | Hi, I'm here |
| • Power on | OK, working now |
| • Speed one | OK, speed one |
| • Speed two | OK, speed two |
| • Speed three | OK, speed three |
| • | |
| • Speed sixteen | OK, speed sixteen |
| • Turn on the light | OK, the light is now on |
| • Turn off the light | OK, the light is now off |
| • Delay shutdown | OK, shutdown 3 minutes later |
| • Power off | OK, goodbye |

Vesta will say "see you later" if no voice commands in 15 second s,but

Vesta will work for you again at any time when you say "Hi Vesta"!

Specifications

Body	Stainless Steel
Power Rating	120V/60Hz (USA & Canada standard)
General Input Power	80W + # of Light x Voltage of Light
Motor Input Power	80 W each
Ampere	3.0 A
Levels Of Speed Control	16
Maximum Airflow	1000 CFM
Noise Level (dB / sone)	Approximately 35 / 0.7 to 67 / 6.5 (Lowest to highest Speed)
Motor Type	Single Chamber Ultra Quiet
# of Motors	1
Fan Type	Centrifugal Squirrel Cage
Control Type	Voice/Gesture/Touch
Filtration Type	Baffle Filter
Illumination	LED 3W 12V
Venting Size	Top, 6 inches Round
Interference Protection	Radio Frequency Interference Protected

* Subject to change without notice, please contact your local reseller for details.

Trouble Shooting

If the range hood or lights does not operate after installation:

Check if the range hood has been plugged in, make sure that all power has been turned back ON, the fuse is not blown and all electrical wiring is properly connected.

Swap out light assembly to working ones to determine whether it is caused by defective bulbs. See replacing the light bulbs on Page 13.

The range hood vibrates when the blower is on:

The range hood might not have been secured properly on to the ceiling or wall.

Check if the motor is secured in place. If not, then tighten the motor in place. Check if the blower wheel is a damaged.

The blower or fan seems weak:

Check that the duct sized used is at least 6". Range hood WILL NOT function efficiently with insufficient duct size & loosely secured.

Check if duct is clogged or if damper unit (half-circular flapper) is not installed correctly or opening properly. A tight mesh on a side wall cap unit might also cause restriction to the air flow.

The lights work but the blower is not spinning at all, is stuck or is rattling.

The blower might be jammed or scraping the bottom due to

shipping damage. Please contact us immediately.

The motor is defective, possibly seized - change the motor.

The hood is not venting out properly:

Make sure the distance between the stove top and the bottom of the hood is within 24" and 31" in distance. Due to different ceiling height configurations, recommended height may not be applicable.

Reduce the number of elbows and length of duct work. Check if all joints are properly connected, sealed, and taped.

Make sure the power is on high speed for heavy cooking

The hood is noiser than normal

The duct is not secure and causes vibration

The smaller duct size than required is using

Replacing the Light Bulb

1. Make sure the range hood is unplugged or turn OFF breaker.
2. Use the small flat crew driver to lift any where around the outsider ring as show in below picture Arrow.
3. Install new light bulb
4. Put back the light set by press it in.
5. Turn ON breaker and range hood to test for operation.



Use and Care Information

Operations

Read and understand all instructions and warnings in this manual before operating the appliance. Save these instructions for future reference.

Always leave safety grills and filters in place. Without these components, operating blowers could catch on to hair, fingers and loose clothing.

NEVER dispose cigarette ashes, ignitable substances, or any foreign objects into blowers.

NEVER leave cooking unattended. When frying, oil in the pan can easily overheat and catch fire. The risk of self-combustion is higher when the oil has been used several times.

NEVER cook on “open” flames under the range hood. Check deep-fryers during use: Superheated oil may be flammable.

Cleaning

The saturation of greasy residue in the blower and filters may cause increased inflammability. Keep unit clean and free of grease and residue build-up at all times to prevent possible fires.

Filters must be cleaned periodically and free from accumulation of cooking residue (see *Maintenance* on Page 33). Old and worn filters must be replaced immediately.

Do not operate blowers when filters are removed. Never disassemble parts to clean without proper instructions. Disassembly is recommended to be performed by qualified personnel only. Read and understand all instructions and warnings in this manual before proceeding.

Maintenance

SAFETY WARNING: Never put your hand into area housing the fan while the fan is operating!

For optimal operation, clean range hood and all baffle/spacer/filter/grease tunnel/oil container regularly. Regular care will help preserve the appearance of the range hood.

Cleaning Exterior surfaces

Clean periodically with hot soapy water and clean cotton cloth. Do not use corrosive or abrasive detergent (e.g. Comet Power Scrub®, EZ-Off® oven cleaner), or steel wool/scoring pads, which will scratch and damage the stainless steel surface. For heavier soil use liquid degrease such as “Formula 409®” or “Fantastic®” brand cleaner.

If hood looks splotchy (stainless steel hood), use a stainless steel cleaner to clean the surface of the hood. Avoid getting cleaning solution onto or into the control panel. Follow directions of the stainless steel cleaner. **CAUTION: Do not leave on too long as this may cause damage to hood finish.** Use soft towel to wipe off the cleaning solution, gently rub off any stubborn spots. Use dry soft towel to dry the hood.

After cleaning, you may use non abrasive stainless steel polish such as 3M® or ZEP®, to polish and buff out the stainless luster and grain. Always scrub lightly, with clean cotton cloth, and with the grain.

DO NOT allow deposits to accumulate or remain on the hood.

DO NOT use ordinary steel wool or steel brushes. Small bits of steel may adhere to the surface and cause rusting.

DO NOT allow salt solutions, disinfectants, bleaches, or cleaning compounds to remain in contact with stainless steel for extended periods. Many of these compounds contain chemicals, which may be harmful. Rinse with water after exposure and wipe dry with a clean cloth.

Cleaning Filters

IMPORTANT: Drain oil from oil containers before oil and residue overflow!

The metal filters fitted by the factory are intended to filter out residue and grease from cooking. It need not be replaced on a regular basis but are required to be kept clean.

Filters should be cleaned after every 30 hours of use.

Remove and clean by hand or dishwasher. Spray "Formula 409®" or equivalent degreasing detergent and leave to soak if heavily soiled. Dry filters and re-install before using hood.

Replacing Filters

Should aluminum grease filters wear out due to age and prolonged use, please contact your local reseller for replacement filters. (Note: Also replace damaged filter that has punctured or broken mesh, bent or broken frame.)

Warranty

TO OBTAIN SERVICE UNDER WARRANTY:

You must present proof of original purchase date.

Please provide an original dated proof of purchase (sales receipt / invoice) in order to obtain service under warranty.

Lifetime Motor Warranty

The motor, which is covered by lifetime warranty, should be provided free of charge by your local reseller given it failed due to manufacturing defects. Subject to the conditions and limitations set forth below, your local reseller should, at its option, either repair or replace it with new or refurbished motor to be functionally equivalent to new. The consumer is responsible for all shipping costs.

One Year Parts Warranty

For one year from the date of original purchase, your local reseller will provide free of charge, non-consumable replacement parts or components that failed due to manufacturing defects. Subject to the conditions and limitations set forth below, your local reseller will, at its option, either repair or replace any part of its products that prove defective by reason of improper workmanship or materials. Repaired parts or replacement products will be provided by your local reseller on an exchange basis, and will be either new or refurbished to be functionally equivalent to new. The consumer is responsible for all shipping costs. Consumable parts not covered by this warranty include but not limited to: Light bulbs, metal, aluminum and charcoal filters.

Who is Covered

This warranty is extended to the original purchaser for products purchased for ordinary home use.

This Warranty Will Be Voided When:

Product damaged through negligence, improper installation, accident, abuse, misuse, natural disaster, insufficient or excessive electrical supply, abnormal mechanical or environmental conditions, or any unauthorized disassembly, repair, modification, or failure to follow installation instructions. When product is used commercially or other than its intended purpose. Damaged because of improper connection with equipment of other manufacturers. Repaired or modified by anyone other than your local reseller's authorized agents. This limited warranty also does not apply to any product on which the original identification information has been altered, obliterated or removed, has not been handled or packaged correctly or has been sold as second-hand.

What is Not Covered:

Consumable parts such as light bulbs, metal and charcoal filters. The natural wear of finish, and wear due to improper maintenance, use of corrosive and abrasive cleaning products, pads, and oven cleaner products. Chips, dents or cracks due to abuse, misuse, freight damage, or improper installation. Damage of product caused by accident, fire, floods or act of God. The manufacturer and/or distributor/reseller is not liable for, and does not cover under warranty, any loss of properties or any costs associated with removing, servicing, installing, or determining the source of problems with this product.

This warranty is valid in the country of the original purchase at retail. It is non-transferable and applies only to the original

purchaser and does not extend to subsequent owners of this product. Any applicable implied warranties, including the warranty of merchantability, are limited in duration to a period of express warranty as provided herein beginning with the date of original purchase at retail and, no warranties, whether express or implied, shall apply to this product thereafter.

To obtain warranty service, you may contact your local reseller from which you purchased this product. Please confirm the terms of your local reseller's policies prior to contacting. Typically, you must include product identification information, including model number and serial number with a detailed description of the problem you are experiencing. You must also include proof of the date of original retail purchase as evidence that the product is within the applicable warranty period.

Disclaimer

Carefully inspect all items for damages before accepting delivery. Note any damages on the freight bill or express receipt. Request name and signature of the carrier's agent and keep copy to support your claim. Upon acceptance of items, owner assumes responsibility for its safe arrival. Report damages to the carrier and file a claim immediately. Failure to do so may result in the denial of your claim. The carrier will furnish you with necessary forms for filing a claim.

Damages caused during transit are not covered under our warranty. Please contact us to file an insurance claim.

Please inspect contents of package(s) carefully upon receiving! We must be notified of any damages and/or missing parts within five (5) days upon your receipt of package(s). Claims will not be accepted after five (5) days. NOTE: Items were thoroughly tested and carefully packed in our factory before shipping.

Products must be returned in good working condition with ALL original parts and documentation packed in ALL original cartons, fillers and shipping cartons. A restocking fee of 15% will be charged for all approved return(s). Exchanges or returns may not be accepted if any packaging is missing.

Make sure to inspect the hood for damages and defects before installation. Appearance flaws of the hood found after installation and not affecting hood performance is not covered under our warranty for returns or exchanges. Service visits not covered under warranty will carry a service charge.

Before Installation: Return for exchange or refund (please see above for acceptable returns). After Installation: NO exchange or refund.

Contact Us

Dear Valued Customer,

Thank you for choosing Vesta as your preferred provider for kitchen appliances. We are committed to providing you with exceptional customer service and support.

If you require assistance with any of our products, please do not hesitate to contact us. You can reach our customer service team by choosing one of the methods below and one of our representatives will respond to you promptly.

Thank you for your business, and we look forward to serving you soon.

Phone:

905-886-5858

9:30am-5:00pm (Eastern Time), Monday to Friday, except holidays

Email:

service@vesta.kitchen

Online form:

<https://www.vesta.kitchen/service>

Sincerely,

The Vesta Service Team

Vesta

Simple Kitchen Solutions

www.vesta.kitchen